



PRODUCT CATALOGUE

The complete line of lug nuts,
lug bolts and wheel locks

Shanghai Baolong Automotive Corporation

- *Wheel bolts*
- *Wheel nuts*
- *Locking bolts*
- *Locking nuts*
- *Other wheel accessories*



2011-2012



Shanghai Baolong Automotive Corporation (Baolong) established in 1997, has successfully grown to be an active player in the automotive industry with world leading position in several product segments including Tire and Wheel Accessories. Baolong products cover 5 continents, including 75 countries & territories. Many world-class automobile manufacturers & Tier 1 suppliers are using Baolong products. Baolong has an ongoing commitment to superior quality, as approved by various international certificates: ISO14001, ISO9001 : 2000 and Ford Q1 award.



NEW

LM203



» **Aluminum Nut**

- Materials: High-strength Aluminum LC4(GB)/7075(ANSI)
- Surface: Anodic Oxidation
- Colors: Red, Yellow, Blue, Gold and Silver

NEW

LM087



» **Stainless Products**

- Stainless steel cap material
- Strengthen the performance of corrosion resistance

NEW

LB020



» **Double anti-theft Locks**

- Double anti-theft wheel locks
- Double anti-theft makes your wheels much safer
- Patent number: ZL200720068593.0

Surface

CHROME	NICKEL	ZINC	BLACK
			
ELECTROPHORESIS		TITANIUM	
			
			

CONTENTS

Wheel Nuts.....	1
Wheel Bolts.....	21
Locking Nuts.....	30
Locking Bolts.....	37
Bushing Washer.....	42
Wheel Sockets.....	43
Wheel Spacers.....	44
Hub Rings.....	45
Adapters.....	46
Truck Bolts And Nuts.....	46
Tools.....	47
Packings.....	48

■ Standard Conical, Closed End

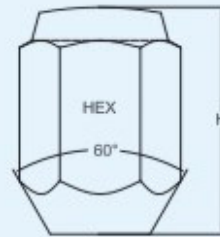

LM001

NO.	HEX	HEIGHT
1	21mm	36mm
2	13/16"	36mm

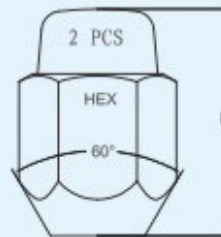
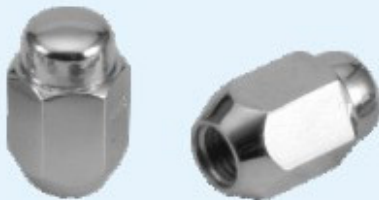

LM002

NO.	HEX	HEIGHT
1	21mm	35mm
2	13/16"	35mm

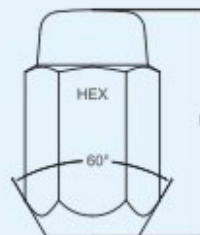

LM003

NO.	HEX	HEIGHT
1	19mm	35mm
2	3/4"	35mm

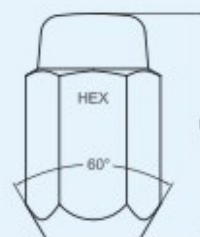

LM004

NO.	HEX	HEIGHT
1	19mm	35mm
2	3/4"	35mm

■ Standard Conical, Closed End

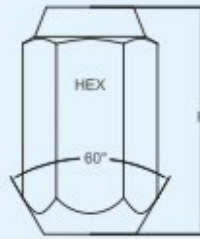

LM005

NO.	HEX	HEIGHT
1	21mm	40.5mm
2	13/16"	40.5mm

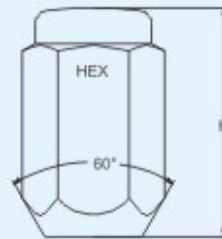

LM007

NO.	HEX	HEIGHT
1	21mm	35.5mm
2	21mm	31mm
3	13/16"	35.5mm
4	13/16"	31mm

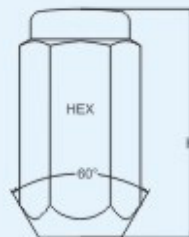

LM009

NO.	HEX	HEIGHT
1	17mm	35.5mm

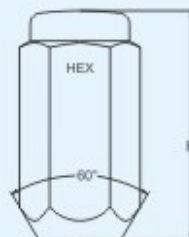
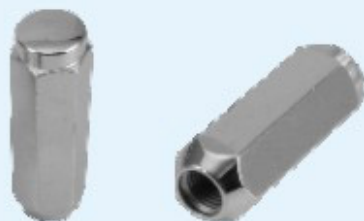

LM010

NO.	HEX	HEIGHT
1	21mm	60mm
2	13/16"	60mm

■ Bulge Conical, Closed End

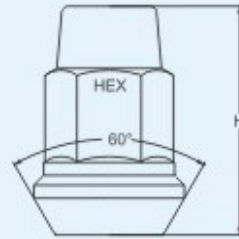

LM015

NO.	HEX	HEIGHT
1	19mm	35mm

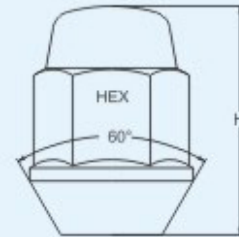

LM017

NO.	HEX	HEIGHT
1	19mm	35mm
2	3/4"	35mm

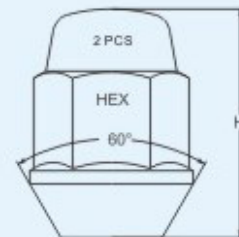

LM018

NO.	HEX	HEIGHT
1	19mm	35mm
2	3/4"	35mm



LM019

NO.	HEX	HEIGHT
1	19mm	35mm
2	3/4"	35mm

■ Bulge Conical, Closed End

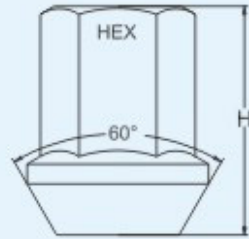

LM021

NO.	HEX	HEIGHT
1	17mm	29mm
2	19mm	29mm
3	17mm	35mm
4	19mm	35mm

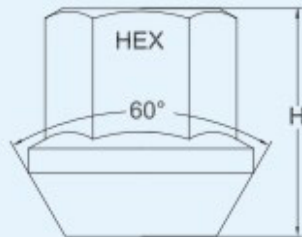

LM022

NO.	HEX	HEIGHT
1	19mm	22mm
2	3/4"	22mm

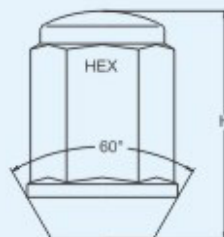

LM023

NO.	HEX	HEIGHT
1	19mm	35mm
2	3/4"	32mm
3	19mm	35mm
4	3/4"	32mm

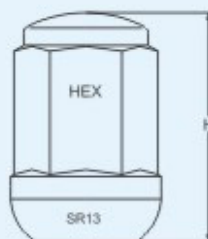

LM023S

NO.	HEX	HEIGHT
1	19mm	35mm
2	3/4"	35mm
3	19mm	32mm
4	3/4"	32mm

■ Bulge Conical, Closed End



LM023ST

NO.	HEX	HEIGHT
1	19mm	35mm
2	3/4"	35mm

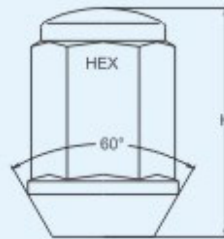

LM024

NO.	HEX	HEIGHT
1	21mm	35mm
2	13/16"	35mm
3	21mm	32mm
4	13/16"	32mm

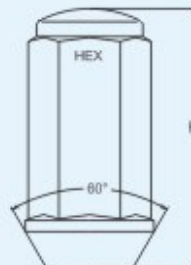

LM025

NO.	HEX	HEIGHT
1	19mm	44.5mm
2	3/4"	44.5mm

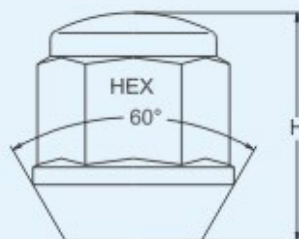
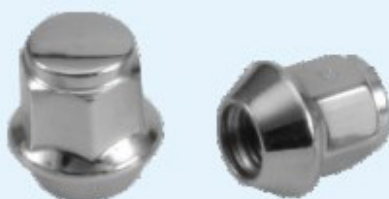

LM026

NO.	HEX	HEIGHT
1	17mm	25mm

■ Bulge Conical, Closed End

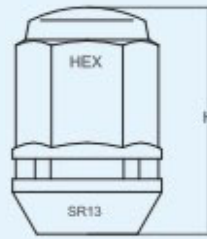

LM087

NO.	HEX	HEIGHT
1	19mm	35mm
2	3/4"	35mm

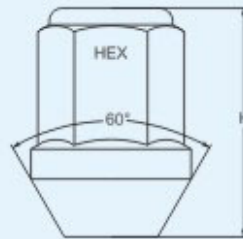

LM123

NO.	HEX	HEIGHT
1	19mm	35mm
2	3/4"	35mm

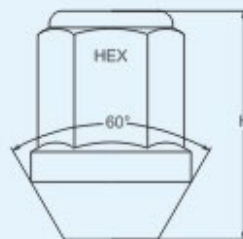

LM123-B

NO.	HEX	HEIGHT
1	19mm	35mm
2	3/4"	35mm

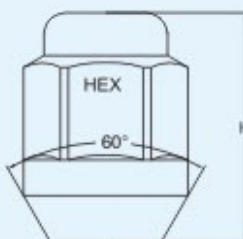

LM323

NO.	HEX	HEIGHT
1	17mm	32mm

■ Dome Conical

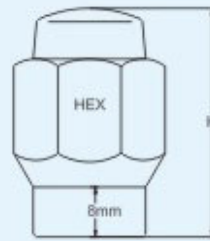

LM061

NO.	HEX	HEIGHT
1	21mm	36.5mm
2	13/16"	36.5mm

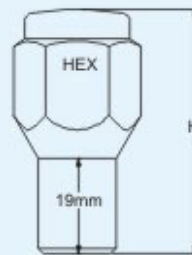

LM063

NO.	HEX	HEIGHT
1	21mm	49mm
2	13/16"	49mm

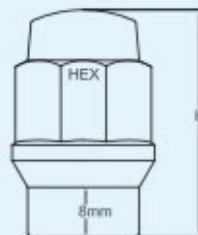

LM065

NO.	HEX	HEIGHT
1	19mm	36.5mm
2	3/4"	36.5mm

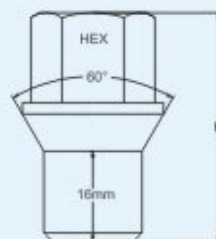

LM066

NO.	HEX	HEIGHT
1	19mm	40.5mm
2	3/4"	40.5mm

■ Standard Conical, Open End

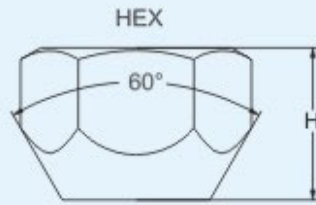

LM011

NO.	HEX	HEIGHT
1	19mm	16mm
2	21mm	16mm
3	13/16"	16mm

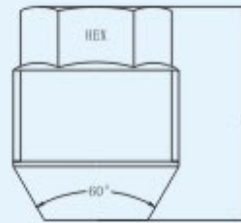

LM086

NO.	HEX	HEIGHT
1	19mm	31mm
2	3/4"	31mm

■ Duplex Conical

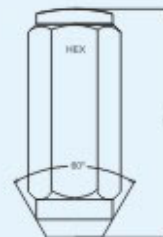

LM029

NO.	HEX	HEIGHT
1	7/8"	60mm
2	19mm	60mm
3	7/8"	39.5mm
4	19mm	39.5mm

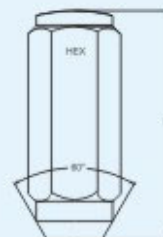

LM031

NO.	HEX	HEIGHT
1	21mm	70mm

■ Bulge Conical, Open End

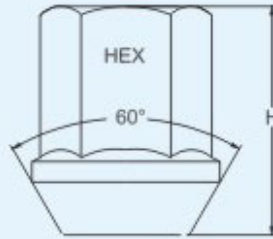

LM006

NO.	HEX	HEIGHT
1	19mm	28mm
2	3/4"	28mm

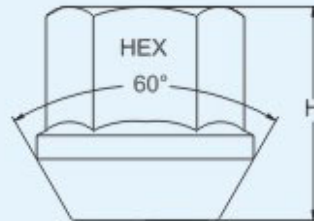

LM013

NO.	HEX	HEIGHT
1	19mm	16mm
2	3/4"	21mm
3	19mm	16mm
4	3/4"	21mm

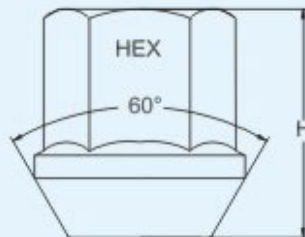

LM014

NO.	HEX	HEIGHT
1	21mm	25mm
2	13/16"	25mm

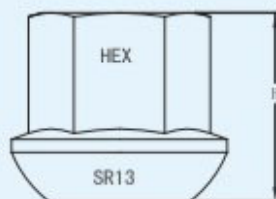

LM014S

NO.	HEX	HEIGHT
1	21mm	25mm
2	13/16"	25mm

■ Bulge Conical, Open End

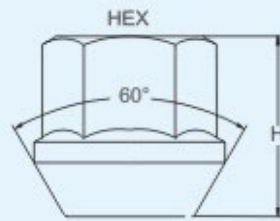

LM016

NO.	HEX	HEIGHT
1	19mm	25mm
2	19mm	17.5mm
3	3/4"	25mm
4	3/4"	17.5mm

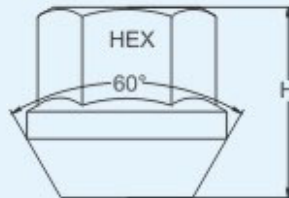

LM113

NO.	HEX	HEIGHT
1	17mm	21mm

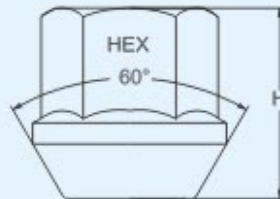

LM316

NO.	HEX	HEIGHT
1	24mm	21mm

■ Dome Conical

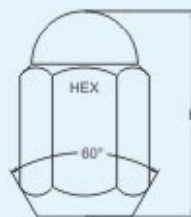

LM035

NO.	HEX	HEIGHT
1	19mm	35mm
2	3/4"	35mm

■ Dome Conical

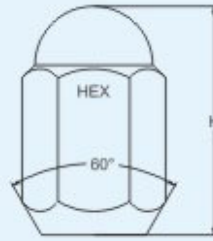

LM036

NO.	HEX	HEIGHT
1	17mm	35mm

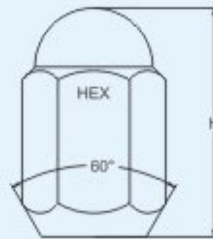

LM037

NO.	HEX	HEIGHT
1	21mm	35mm
2	13/16"	35mm

■ Mag

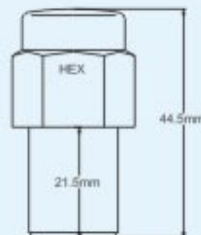

LM047

NO.	HEX	HEIGHT
1	21mm	32mm
2	21mm	44.5mm
3	13/16"	32mm
4	13/16"	44.5mm

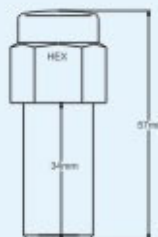

LM050

NO.	HEX	HEIGHT
1	21mm	57mm
2	13/16"	57mm

■ Mag

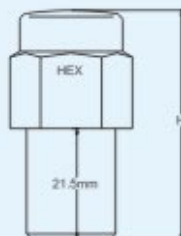

LM051

NO.	HEX	HEIGHT
1	19mm	42.5mm
2	3/4"	42.5mm

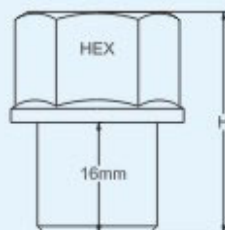

LM057

NO.	HEX	HEIGHT
1	21mm	32mm
2	21/16"	32mm

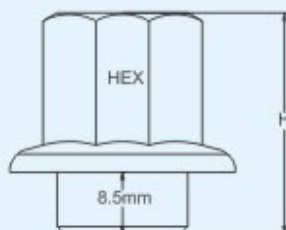

LM059

NO.	HEX	HEIGHT
1	19mm	30.5mm
2	3/4"	30.5mm

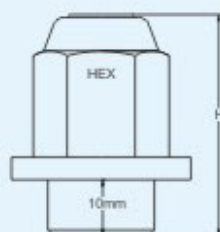

LM078

NO.	HEX	HEIGHT
1	21mm	39.5mm
2	13/16"	39.5mm

Inner Hex

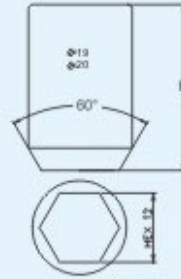

LM067

NO.	HEX	HEIGHT
1	19mm	32mm
2	20mm	32mm

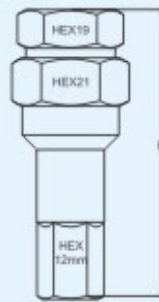

LM067-KEY

NO.	HEX	HEIGHT
1	19/21mm	61mm

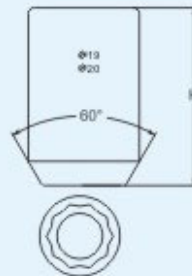

LM167

NO.	HEX	HEIGHT
1	19mm	32mm
2	20mm	32mm

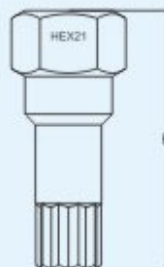

LM167-KEY

NO.	HEX	HEIGHT
1	19/21mm	55mm

Inner Hex

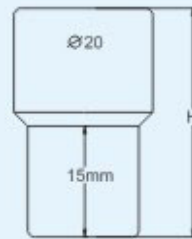

LM072

NO.	HEX	HEIGHT
1	19/21mm	32mm

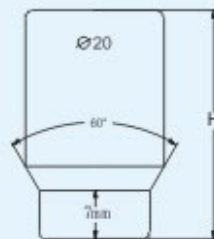

LM075

NO.	HEX	HEIGHT
1	19/21mm	33mm

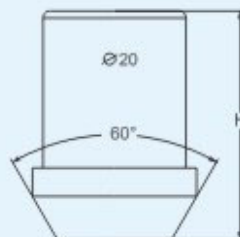

LM080

NO.	HEX	HEIGHT
1	19/21mm	45mm

PCD Nut

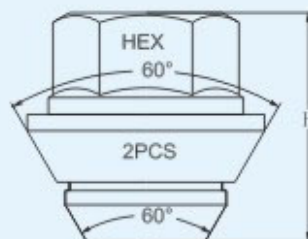

LM076

NO.	HEX	HEIGHT
1	19mm	27mm
2	3/4"	27mm

PCD Nut

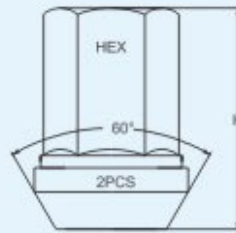

LM166

NO.	HEX	HEIGHT
1	17mm	32mm
2	19mm	32mm



LM258

NO.	HEX	HEIGHT
1	19mm	35mm
2	3/4"	35mm

Stainless Nuts

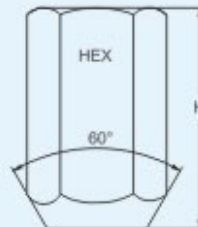
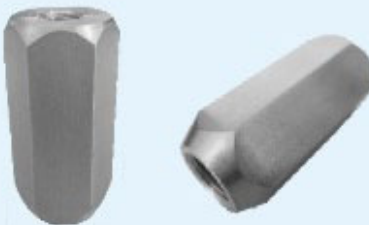

LM001L

NO.	HEX	HEIGHT
1	21mm	60mm
2	13/16"	60mm

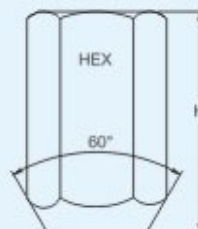
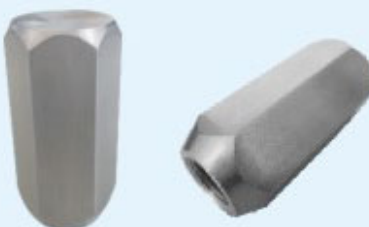

LM007L

NO.	HEX	HEIGHT
1	21mm	60mm
2	13/16"	60mm

■ Heptagon Nuts

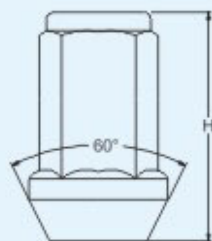

LM070

NO.	HEX	HEIGHT
1	19/21mm	32mm

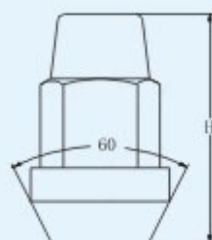

LM081

NO.	HEX	HEIGHT
1	19/21mm	40mm

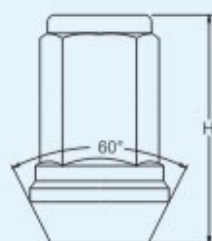

LM082

NO.	HEX	HEIGHT
1	19/21mm	35mm

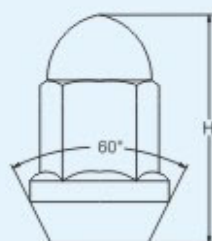
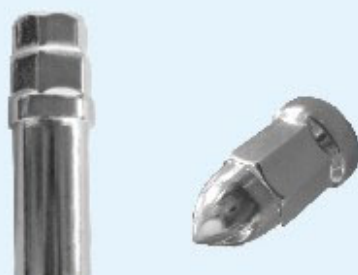

LM090

NO.	HEX	HEIGHT
1	19/21mm	40mm



■ **Heptagon Nuts**

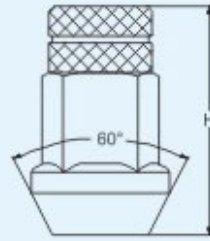

LM091

NO.	HEX	HEIGHT
1	19/21mm	40mm



■ **Duplex HEX**

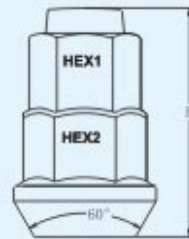

LM084

NO.	HEX1	HEX2	HEIGHT
1	17mm	19mm	45mm

■ **Nuts With Washer**

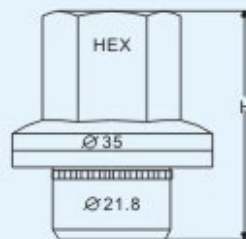

LM083

NO.	HEX	HEIGHT
1	21mm	41mm
2	7/8"	41mm



LM259

NO.	HEX	HEIGHT
1	19mm	34mm
2	3/4"	34mm

Nuts With Washer



LM359

NO.	HEX	HEIGHT
1	21mm	50mm
2	13/16"	50mm



LM459

NO.	HEX	HEIGHT
1	21mm	49.5mm
2	13/16"	49.5mm

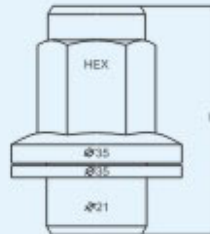

LM559

NO.	HEX	HEIGHT
1	21mm	49.5mm
2	13/16"	49.5mm



LM659

NO.	HEX	HEIGHT
1	21mm	47mm
2	13/16"	47mm

Nuts With Washer

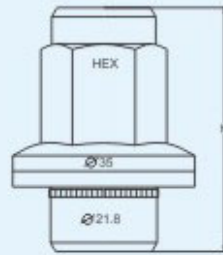

LM759

NO.	HEX	HEIGHT
1	21mm	47mm
2	7/8"	47mm

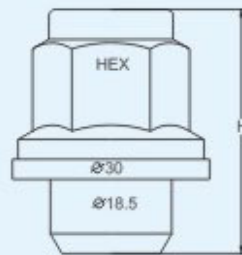

LM859

NO.	HEX	HEIGHT
1	21mm	37mm
2	13/16"	37mm

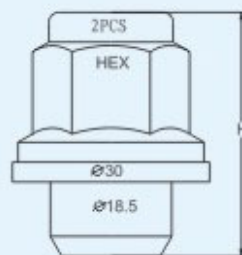

LM859C

NO.	HEX	HEIGHT
1	21mm	37mm
2	13/16"	37mm

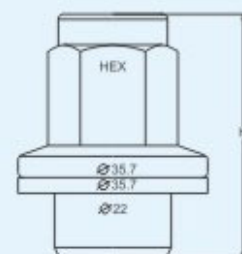

LM959

NO.	HEX	HEIGHT
1	21mm	46mm
2	13/16"	46mm

■ Aluminum Lug Nuts



LM201

NO.	HEX	HEIGHT
1	19mm	50mm
2	3/4"	50mm

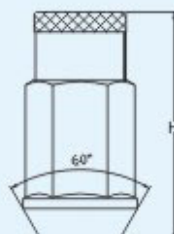

LM202

NO.	HEX	HEIGHT
1	19mm	50mm
2	3/4"	50mm

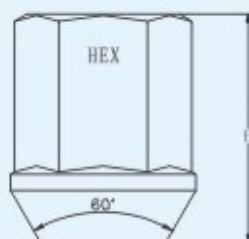

LM203

NO.	HEX	HEIGHT
1	19mm	34mm
2	3/4"	34mm

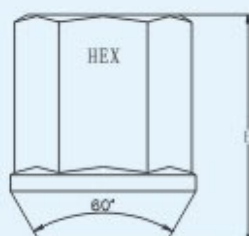

LM204

NO.	HEX	HEIGHT
1	19mm	34mm
2	3/4"	34mm

Cone Seat

LG001

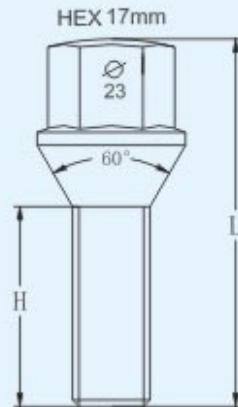

NO.	HEIGHT	LENGTH
1	20mm	45mm
2	24mm	52mm
3	26mm	54mm
4	28mm	56mm
5	30.5mm	57mm
6	40mm	68mm
7	50mm	78mm
8	60mm	88mm

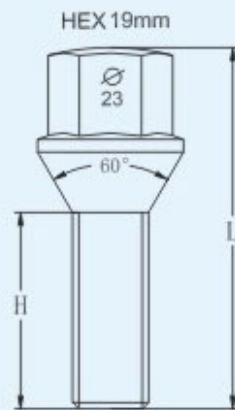

LG002

NO.	HEIGHT	LENGTH
1	25mm	53mm
2	28mm	56mm
3	40mm	68mm
4	45mm	73mm
5	50mm	78mm

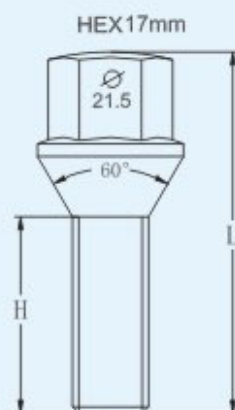

LG003

NO.	HEIGHT	LENGTH
1	23.5mm	49mm
2	27mm	53.5mm
3	40.5mm	67mm

Cone Seat

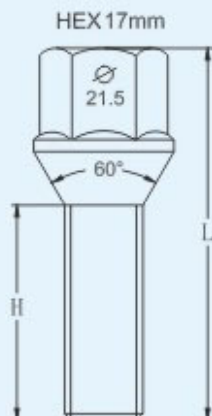

LG004

NO.	HEIGHT	LENGTH
1	25mm	53mm
2	28mm	56mm
3	40mm	68mm
4	45mm	73mm

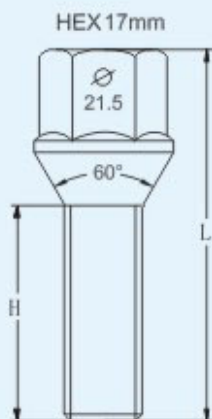

LG004-B

NO.	HEIGHT	LENGTH
1	20mm	43.5mm
2	38mm	64mm
3	42mm	68mm
4	47mm	73mm

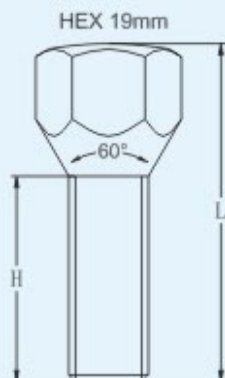

LG006

NO.	HEIGHT	LENGTH
1	22mm	38mm
2	27mm	51mm
3	31mm	61mm
4	40mm	68mm

Cone Seat

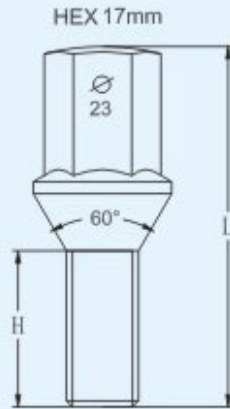

LG008

NO.	HEIGHT	LENGTH
1	25mm	56mm
2	27mm	58mm
3	31mm	57mm
4	33mm	67mm
5	40mm	74mm
6	58mm	92mm

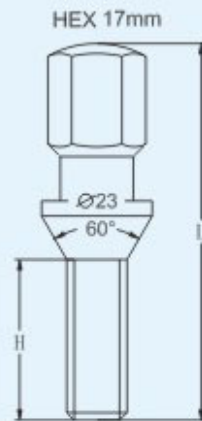

LG011

NO.	HEIGHT	LENGTH
1	26mm	66mm
2	32mm	75mm
3	42mm	75mm
4	48mm	88mm

Ball Seat

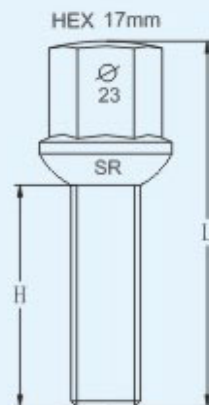

LG007

NO.	HEIGHT	LENGTH
1	21mm	39mm
2	23mm	45mm
3	25mm	51mm
4	27mm	52mm
5	32mm	57mm
6	42mm	68mm
7	45mm	70mm

■ Ball Seat

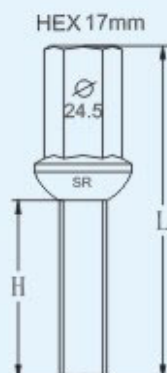

LG009

NO.	HEIGHT	LENGTH
1	27mm	57mm
2	29mm	59mm
3	32mm	52mm
4	40mm	81mm
5	40mm	70mm
6	45mm	84mm

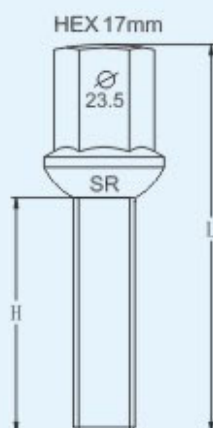

LG010

NO.	HEIGHT	LENGTH
1	22mm	52mm
2	24mm	73mm
3	26mm	71mm
4	40mm	74mm
5	46mm	76mm



LG012

NO.	HEIGHT	LENGTH
1	30.5mm	85mm
2	30.5mm	70mm
3	39mm	95mm

■ Ball Seat

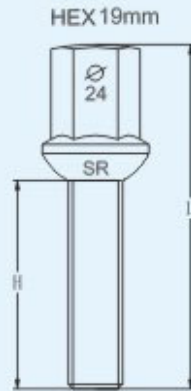

LG020

NO.	HEIGHT	LENGTH
1	22mm	52mm
2	24mm	66mm
3	29mm	66mm
4	33mm	63mm
5	40mm	70mm
6	46mm	76mm

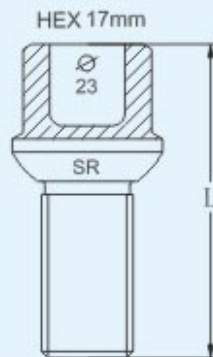

LG207

NO.	HEIGHT	LENGTH
1	32mm	75mm

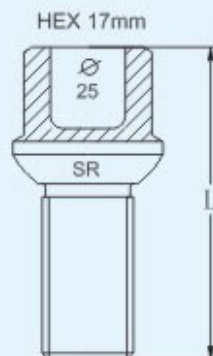

LG307

NO.	HEIGHT	LENGTH
1	20.5mm	40mm
2	23.5mm	45mm
3	34mm	58mm

Ball Seat

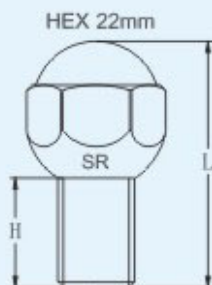

LG407

NO.	HEIGHT	LENGTH
1	20mm	45mm

PCD Bolt

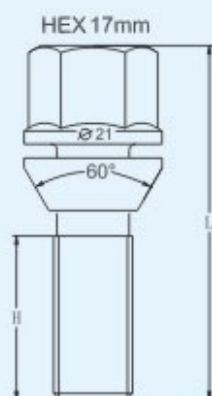

LG014

NO.	HEIGHT	LENGTH
1	25mm	50mm
2	26mm	51mm
3	30mm	55mm
4	35mm	60mm
5	40mm	65mm

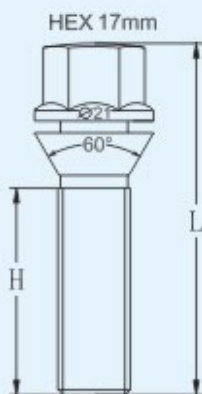

LG015

NO.	HEIGHT	LENGTH
1	26mm	54mm
2	28mm	56mm
3	35mm	63mm
4	40mm	68mm
5	45mm	73mm
6	50mm	76mm

PCD Bolt

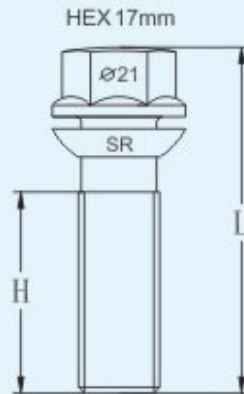

LG016

NO.	HEIGHT	LENGTH
1	26mm	51mm
2	28mm	53mm
3	35mm	60mm
4	40mm	65mm
5	45mm	70mm
6	50mm	75mm

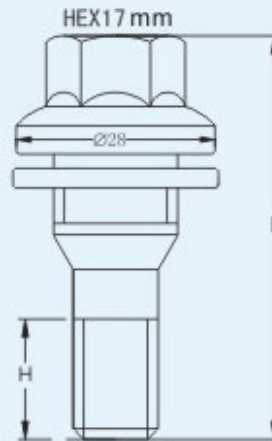

LG018

NO.	HEIGHT	LENGTH
1	17mm	57mm
2	20mm	60mm
3	25mm	65mm

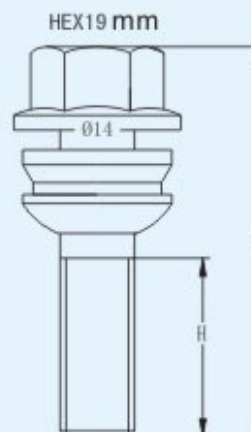

LG019

NO.	HEIGHT	LENGTH
1	24mm	63mm
2	40mm	79mm
3	45mm	84mm

PCD Bolt

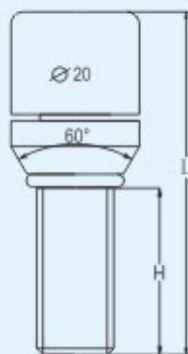

LG021

NO.	HEIGHT	LENGTH
1	26mm	53.5mm
2	28mm	55.5mm
3	32mm	59.5mm



Allen Key Bolt

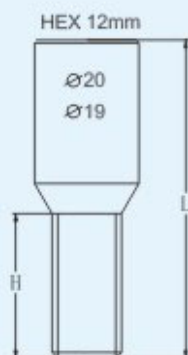

LG013

NO.	HEIGHT	LENGTH
1	25mm	55mm
2	28mm	56mm
3	30mm	57mm
4	40mm	67mm
5	45mm	78mm

Heptagon Bolts

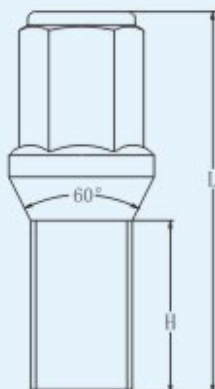

LG023

NO.	HEIGHT	LENGTH
1	26mm	59mm
2	28mm	61mm



Wheel Studs

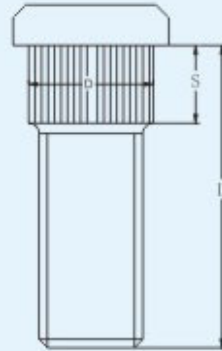

LG801

NO.	DIA.	SHOULDER	LENGTH
1	12.3mm	9mm	34mm
2	12.2mm	10mm	36mm
3	10.5mm	14.4mm	37.5mm
4	15.9mm	9.5mm	45.5mm

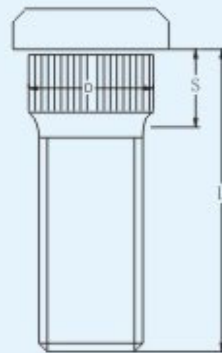

LG802

NO.	DIA.	SHOULDER	LENGTH
1	14.1mm	11.5mm	38.5mm
2	12.8mm	9mm	41.5mm
3	12.8mm	16mm	42mm
4	14.4mm	14.4mm	45mm
5	14.7mm	19mm	46mm
6	12.5mm	15.6mm	47mm

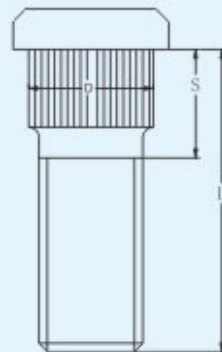

LG803

NO.	DIA.	SHOULDER	LENGTH
1	12.7mm	18mm	31.5mm
2	14.1mm	17.5mm	36mm
3	14.4mm	17mm	40mm
4	14.3mm	17.8mm	44.5mm

■ Conical, Adapter Key, Closed-end

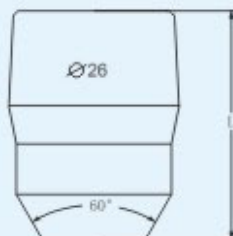

LS001

NO.	LENGTH	HEX
1	36mm	17/19mm
2	40mm	17/19mm

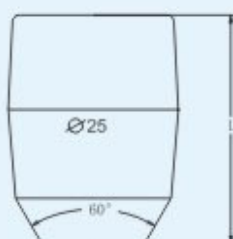

LS002

NO.	LENGTH	HEX
1	35mm	17/19mm
2	40mm	17/19mm

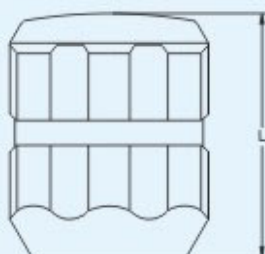

LS003

NO.	LENGTH	HEX
1	35mm	17/19mm

Wheel Studs

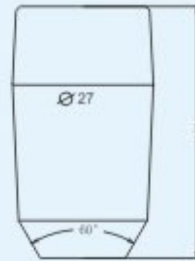

LS004

NO.	LENGTH	HEX
1	52mm	17/19mm

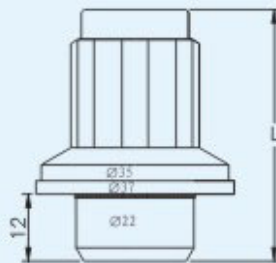

LS006

NO.	LENGTH	HEX
1	47mm	23mm

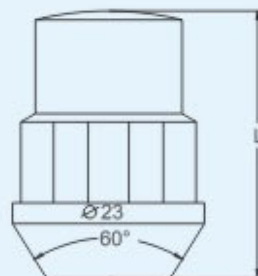

LS009

NO.	LENGTH	HEX
1	32mm	17/19mm

■ Conical, Adapter Key, Closed-end

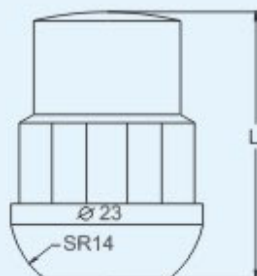

LS009S

NO.	LENGTH	HEX
1	32mm	17/19mm

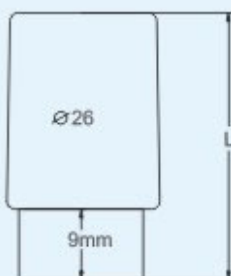

LS012

NO.	LENGTH	HEX
1	38mm	17/19mm

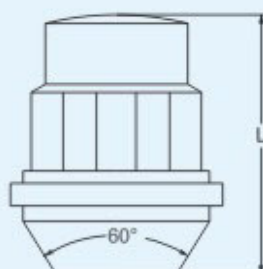

LS016

NO.	LENGTH	HEX
1	35mm	17/19mm

Wheel Studs

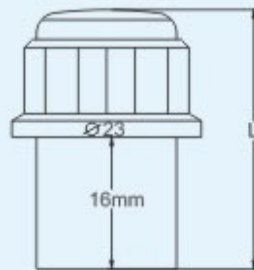

LS017

NO.	LENGTH	HEX
1	31.5mm	17/19mm

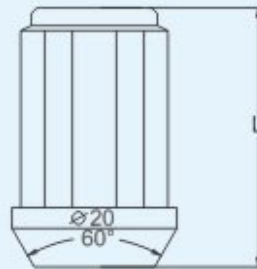

LS024

NO.	LENGTH	HEX
1	32mm	17/19mm
2	35mm	17/19mm

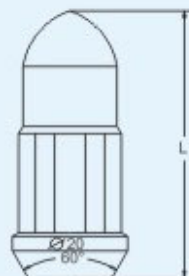

LS025

NO.	LENGTH	HEX
1	35mm	17/19mm
2	50mm	17/19mm

■ Conical, Adapter Key, Open-end

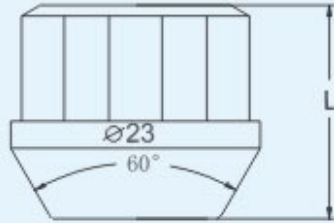

LS008

NO.	LENGTH	HEX
1	21mm	17/19mm

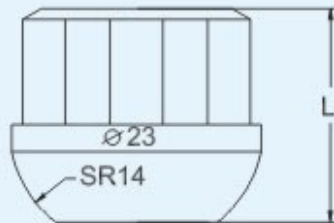

LS008S

NO.	LENGTH	HEX
1	21mm	17/19mm

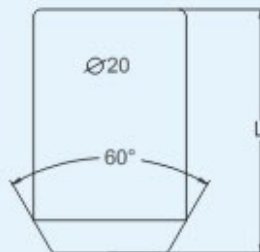

LS018

NO.	LENGTH	HEX
1	32mm	17/19mm

■ Conical, Adapter Key, Open-end



Stainless nuts

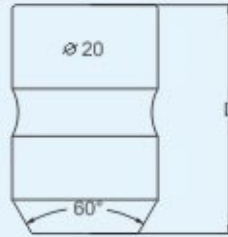

LS022

NO.	LENGTH	HEX
1	32mm	17/19mm

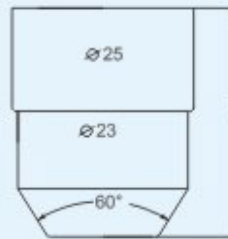

LS015

NO.	LENGTH	HEX
1	30.3mm	17/19mm

■ Locks With Washer

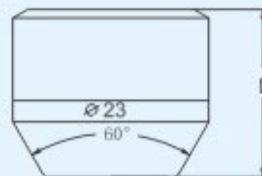

LS005

NO.	LENGTH	HEX
1	22mm	17/19mm

Locks With Washer

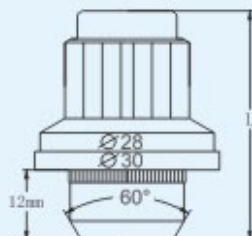

LS023

NO.	LENGTH	HEX
1	37mm	17/19mm

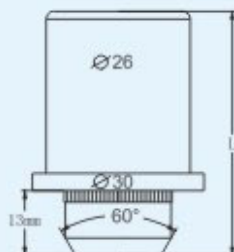

LS026

NO.	LENGTH	HEX
1	49mm	17/19mm

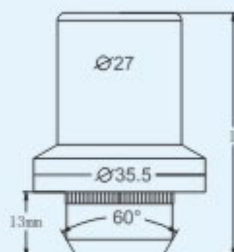

LS027

NO.	LENGTH	HEX
1	46mm	17/19mm

■ Cone Seat, Socket Key

LB001

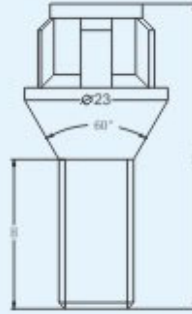

NO.	HEIGHT	LENGTH	HEX
1	23.5mm	49mm	19/21mm
2	25mm	50mm	19/21mm
3	27mm	52mm	19/21mm
4	32mm	57mm	19/21mm
5	37mm	62mm	19/21mm
6	40mm	65mm	19/21mm
7	46mm	71mm	19/21mm
8	50mm	75mm	19/21mm

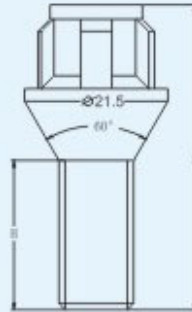

LB002

NO.	HEIGHT	LENGTH	HEX
1	23.5mm	44mm	19/21mm
2	27mm	47mm	19/21mm
3	33mm	53.5mm	19/21mm
4	40.5mm	61mm	19/21mm

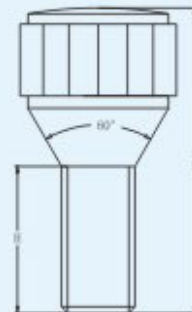

LB013

NO.	HEIGHT	LENGTH	HEX
1	25mm	45mm	17/19mm
2	33mm	53mm	17/19mm

■ Ball Seat, Socket Key

LB003

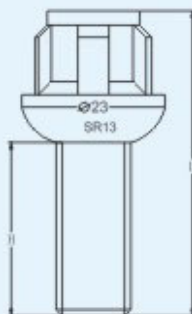

NO.	HEIGHT	LENGTH	HEX
1	20.6mm	42.6mm	19/21mm
2	24.1mm	46.1mm	19/21mm
3	25mm	47mm	19/21mm
4	27mm	49mm	19/21mm
5	33mm	55mm	19/21mm
6	40mm	62mm	19/21mm
7	45mm	67mm	19/21mm

■ Cone Seat, Adapter Key

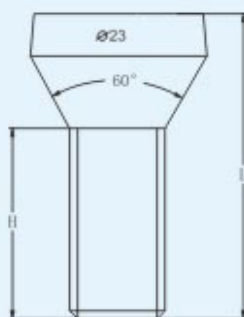

LB004

NO.	HEIGHT	LENGTH	HEX
1	38mm	41mm	17mm
2	31mm	44mm	17mm

LB011

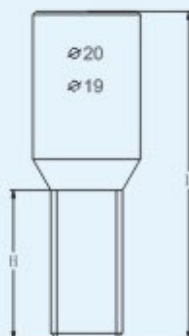

NO.	HEIGHT	LENGTH	HEX
1	25mm	55mm	19/21mm
2	28mm	56mm	19/21mm
3	30mm	57mm	19/21mm
4	40mm	67mm	19/21mm
5	45mm	78mm	19/21mm



■ Cone Seat, Socket Key

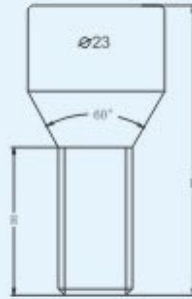

LB006

NO.	HEIGHT	LENGTH	HEX
1	25mm	48mm	17mm
2	27mm	52mm	17mm
3	29mm	54mm	17mm
4	40mm	65mm	17mm
5	45mm	70mm	17mm

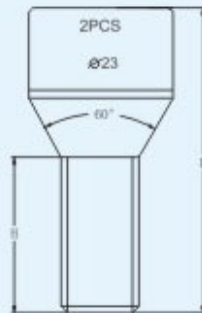

LB016

NO.	HEIGHT	LENGTH	HEX
1	26mm	51mm	17/19mm
2	27mm	52mm	17/19mm
3	28mm	53mm	17/19mm
4	49mm	54mm	17/19mm
5	40mm	65mm	17/19mm

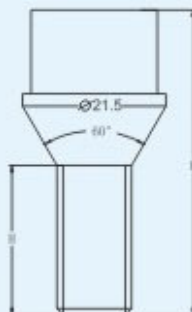

LB020

NO.	HEIGHT	LENGTH	HEX
1	25mm	53mm	17mm
2	28mm	56mm	17mm
3	40mm	68mm	17mm
4	50mm	70mm	17mm



■ PCD Locking Bolts

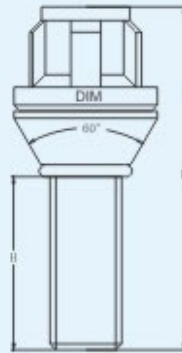

LB010

NO.	HEIGHT	LENGTH
1	26mm	54mm
2	28mm	56mm
3	29mm	57mm
4	33mm	61mm
DIM		21/24mm
HEX		19/21mm

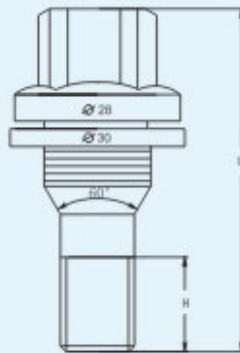

LB012

NO.	HEIGHT	LENGTH	HEX
1	16mm	58mm	17mm

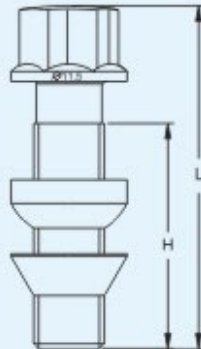

LB021

NO.	HEIGHT	LENGTH	HEX
1	16mm	58mm	17mm

■ Ball Seat ,Adapter Key

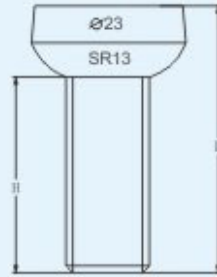

LB005

NO.	HEIGHT	LENGTH	HEX
1	27mm	52mm	19/21mm
2	31mm	42mm	19/21mm

■ Hup Cap Locks

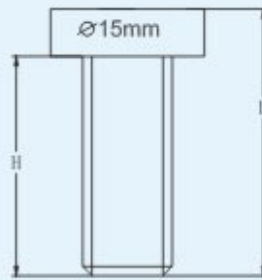

LB007

NO.	HEIGHT	LENGTH
1	16mm	22mm
2	18mm	24mm
3	19.5mm	25.5mm
4	23.5mm	24mm
5	38mm	24mm

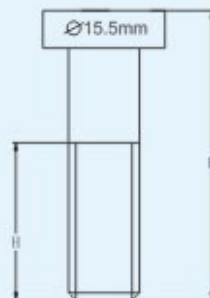

LB008

NO.	HEIGHT	LENGTH
1	18mm	68mm
2	35mm	45mm

Bushing Washer

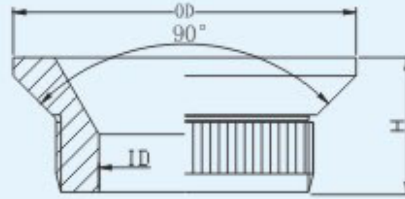

I101

NO.	HEIGHT	ID	OD
I001	11mm	14mm	28mm
I002	10mm	14mm	28mm
I003	10.9mm	15mm	30mm
I004	11mm	16mm	30.5mm

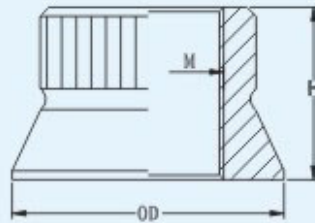

I201



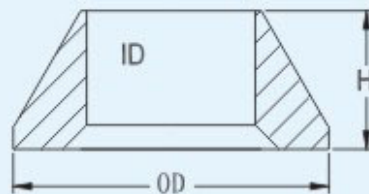





NO.	HEIGHT	M	OD
I201	13.8mm	12x1.5	22.2mm
I202	13.8mm	14x1.5	22.2mm

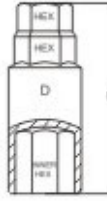

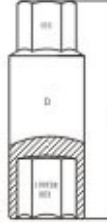
W301

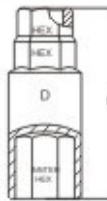
NO.	HEIGHT	ID	OD
W301	11.5mm	14mm	26.2mm
W302	10mm	1.5mm	24.9mm

Wheel Socket

PICTURE	PART NO.	HEX	INNER HEX	D	L
 	A001	17X19mm	19mm	26mm	68mm
		19X21mm	17mm	24mm	75mm
		19X21mm	19mm	27mm	68mm
		19X21mm	21mm	28mm	75mm
 	A002	17mm	17mm	25mm	70mm
		19mm	19mm	27mm	75mm
		21mm	21mm	30mm	68mm
		21mm	19mm	28mm	68mm
		19mm	17mm	26mm	70mm
 	A003	19X21mm	17mm	24mm	68mm
		19X21mm	19mm	27mm	65mm
		19X21mm	21mm	28mm	68mm
 	A004	19mm	19mm	27mm	65mm
		21mm	21mm	30mm	65mm
		21mm	19mm	28mm	65mm
		19mm	17mm	26mm	68mm
 	A005		17mm	24mm	78mm
			19mm	26mm	78mm
			21mm	28mm	78mm

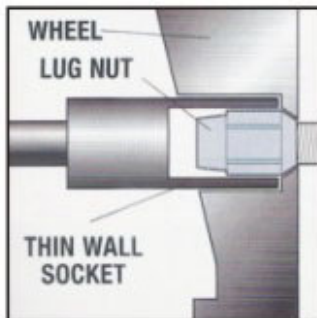

Thin Wall Sockets are designed to work with aftermarket Wheels that leave a minimum of clearance between the wheel and the lug nut.

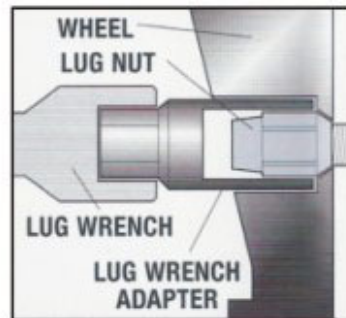

BaoLong Lug Wrench Adapters enable you to use the stock lug wrench on aftermarket lug nuts.

■ Wheel Spacer



Picture	ID	PCD	ID	OD	Thickness	Holes
	SPA-03	101.5-126.5mm	78mm	151mm	3mm	4&5
	SPA-05	101.5-126.5mm	78mm	151mm	5mm	4&5
	SPA-08	101.5-126.5mm	78mm	151mm	8mm	4&5
	SPB-03	98.5-114.5mm	76mm	134mm	3mm	4&5
	SPB-05	98.5-114.5mm	76mm	134mm	5mm	4&5
	SPB-08	98.5-114.5mm	76mm	134mm	8mm	4&5
	SPB-10	98.5-114.5mm	76mm	134mm	10mm	4&5
	SPC-03	100-127mm	78.3mm	149mm	3mm	4
	SPC-06	100-127mm	78.3mm	149mm	6mm	4
	SPD-03	100-127mm	78.2mm	149mm	6mm	5
	SPD-06	100-127mm	78.2mm	149mm	6mm	5
	SPF-04	94.5-126mm	73.3mm	148mm	4mm	5
	SPF-07	94.5-126mm	73.3mm	148mm	7mm	5

■ **Central Ring**



Materials: Plastic
 Colours: Red, Yellow, Black, Other colors

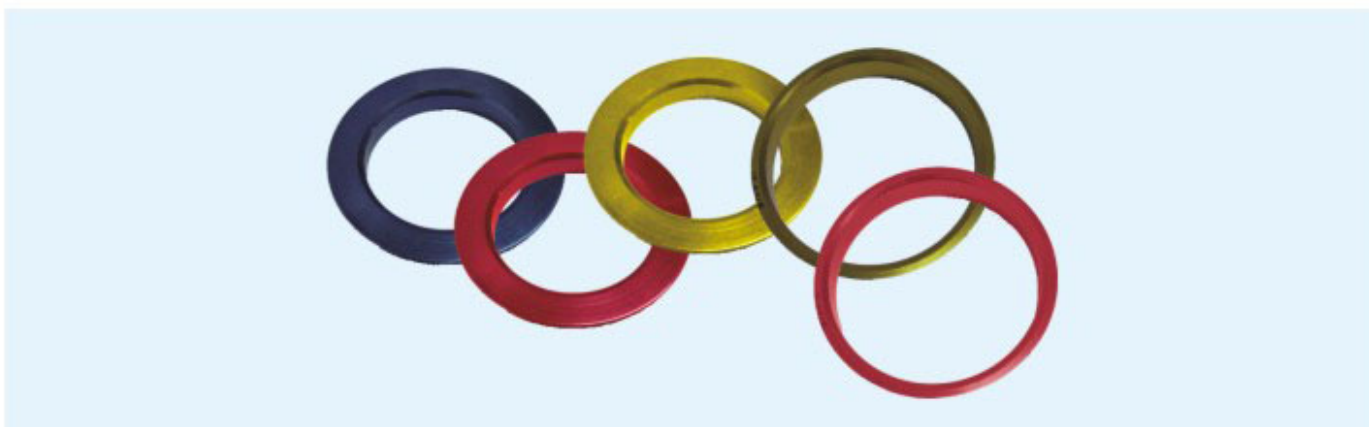

Materials: Aluminum alloy
 Colours: Red, Yellow, Black, Other colors

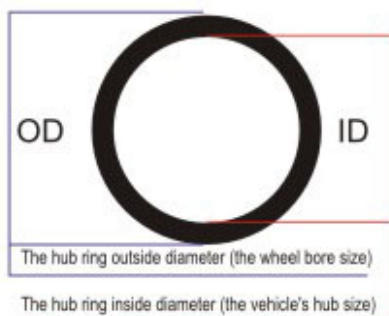

- 1 Find the aftermarket wheel bore size Wheel bore size = Hub Ring outside diameter = Last four digits of Hub Ring Part Number
Example: Baolong = 74.1mm

- 2 Find vehicle hub size Wheel bore size = Hub Ring outside diameter = Last four digits of Hub Ring Part Number
Example: 1995 Toyota Camry = 67.1mm

- 3 Your Hub Centric Ring Part Number is= **74.1mm-67.1mm**

■ **Adapters**



■ **Bolts And Nuts For Truck/Bus/Heavy Duty Vehicle/Trailer Series**



Common Material: 35/45/40CrMo/ 42CrMo
Finish: Spray paint/Phosphate+ oil/Black/Zinc plated/Dacromet
Quality: Grade 8.8/Grade 10.9

Tools
Multiple Sockets
BL001LG

PART# SK01-17 SK01-19 SK01-21

- ▶ Every package includes:
one 1/2" drive wrench, 3 different sockets fit for sizes of 17mm, 18mm, 19mm, 20mm, 21mm, 22mm, 23mm, 24mm, 25mm, 11/16" 3/4" and 13/16" and one pouch for storage.
- ▶ Torque strength reach 440 lb-ft. even stronger than industrial standard requirement of 360 lb-ft.

BLTC01

SIZES AVAILABLE

12MM x 1.25
12MM x 1.50
12MM x 1.75
14MM x 1.50
14MM x 2.00
7/16" - 20
1/2" - 20
9/16" - 18

Thread Size Gauges

This set has both male and female threads for checking lug nuts, wheel locks and wheel studs. Eight machined gauges let you verify the most common bolt and lug thread sizes.

■ **Packings**



PK01



PK02



PK03



PK04



PK05



PK06



PK07



PK08





Multistage Cold Former



Strength Testing



Salt Spray Test Chamber Laboratory



We strive to be reliable, responsible, and efficient while constantly improving our products, processes and customer service.



71, Maosheng Road, Dongjing, Songjiang,
Shanghai 201619, China
Tel: +86-21-57690000(70 Lines)
Fax: +86-21-57690035
E-mail: sbic@baolong.biz
Web: www.baolong.biz

- WI
- WI
- Lo
- Lo
- Of

www.baolong.biz

20